

DUCK – 16 oz fabric in royal blue, forest green or safety yellow. This material resists fire, water and mildew and has earned CFM approval. For use as curtains, protective sleeves and light grinding and welding screens.

M1050	Blue	61" width (blue); 72" width
M1051G	Green	(yellow & green) 200 yds/roll
M1051Y	Yellow	Service range: -10/160°F

WELD-TEX™ – Carrying CFM approval, vinyl-coated 16 oz Weld-TEX resists oils, alkalis and most acids along with fire, water and mildew. Available in blue, green or yellow. For use as curtains or vertical partitions, welding and grinding screens.

M1053B	Blue	72" width; 100 yds/roll
M1053Y	Yellow	Service range: -40/180°F
M1053G	Green	

ZEBRA – Same fabric specifications as Weld-TEX with distinctive yellow and black stripes on the face and solid black on the reverse.

M1054	Black/Yellow	72" width; 100 yds/roll
		Service range: -40/180°F

ARMOR-PLEAT™ – Heavy duty 50 oz black vinyl abrasion resistant material. Ideal for grinding applications and equipment protection, especially where welding sparks may come in contact with the material.

M1061	Black	60" width; 50 yds/roll
		Service range: -10/180°F

MESH NETTING – 3 oz nylon with 1/2" hexagonal mesh with white vinyl edge binding. treated with flame retardant chemicals for CFM approval. General purpose use. Not to be used as a personal restraint.

M1087	White	42" width; 100'/roll
		Service range: 0/500°F

FRO-SIL™ – 19 oz fiberglass impregnated with a flame retardant silicon rubber, 25% by total weight. Treatment provides a greater life and improved resistance to abrasion, flexing, tearing and puncture. Water and oil resistant. This standard duty product meets the requirement of NRC Guide I.36 and Military Spec MIL-I-24244.

M1079	Rust	60" width; 50 yds/roll
		Service range: 0/500°F

HEAT REFLECTIVE THERMO SHIELD – 28 oz fiberglass fabric. Features one surface faced with a highly reflective aluminized mylar for reflection of radiant heat. The other side is treated with a flame retardant coating providing moisture resistance.

M1084	Sliver/Black	40" width; 50 yds/roll
		Service range: 0/500°F

FRO-GUARD™ – Fro-Guard is a 28 oz fiberglass coated with a rubberized (neoprene) coating on one side and an acrylic finished on other side. Offers excellent resistance to abrasion. Intended use is for medium to heavier duty welding, heat source isolation and general protection against grinding, cutting and spraying.

M1085	Gold	40", 60", 72" width;
		50 yds/roll
		Service range: -30/1000°F

FRO-TEX™ – 26 oz fiberglass, texturized finish on one side. Offers better abrasion resistance and tensile strength when compared to untreated fiberglass. For light and medium duty welding and can be used for heat source isolation. Can also be used for general purpose grinding, cutting and spraying.

M1082	Tan	40" width; 50 yds/roll
		Service range: -30/1000°F

SILICA – 19 oz premium silica fabric with special coating for increased surface abrasion resistance. Coating improves handling properties and increases resistance to oils and greases. Use for heat relieving, high temperature and molten metal protection. Can also be used for pads and welding covers. Can meet military specifications: C-24576SH and I-24244. Silica is processed and woven in the USA.

M1080	Tan	36" width; 50 yds/roll
		Service range: -30/3000°F

THERMO-SHIELD™ – 23 oz Aramid blend fabric coated with vermiculite and neoprene on both sides. Fabric provides premium protection and performance. Special coating sheds welding spatter and molten metal up to 3000°F at an incline of 15-20°. Offers excellent resistance to abrasion and suppresses smoke generation. Ideal for heavy duty welding, grinding, cutting and spraying, and heat source isolation. Intended use as welding covers and curtains. Available in blue or black.

M1089	Blue	40", 60", 72" width; 50 yds/roll
M1089B	Black	Service range: -30/1200°F

Commercial Grade ROLL GOODS

SILICA – Our best value Silica in both 18 and 34 oz. weight. Same heat and application uses as our specialty Silica fabric but without the abrasion resistance coating. Can meet military specifications: C-24576SH and I-24244. Silica is processed and woven in the USA.

M18ST (18 oz.)	Tan	36" width; 50 yds/roll
M34ST (34 oz.)		Service range: -30/3000°F

NEOSHIELD – 24 oz neoprene treated fiberglass fabric coating on one side, intended for light to medium duty welding and protection from grinding, cutting and spraying. Offers improved resistance to abrasion and tearing when compared to untreated fiberglass.

M24GNY	Yellow	72" width; 50 yds/roll; 24 oz.
M24GNB	Blue	Service range: -30/3000°F

FIRST SIGHT THERMOSHIELD – 24 oz neoprene treated fiberglass fabric in highly visible iridescent colors to signal hazards associated with welding, grinding or spraying in production areas. Intended for light to medium duty welding and protection. Offers improved resistance to abrasion and tearing when compared to untreated fiberglass.

M24GNIO	Orange	72" width; 50 yds/roll
M24GNII	Yellow	Service range: -30/3000°F
M24GNIG	Green	

WELDFLEX 1 – 21 oz with neoprene and vermiculite coating on both sides to shed spark and light spatter. Offers better resistance to abrasion and tensile strength when compared to untreated fiberglass. Intended for light to medium duty welding, heat source isolation, grinding, cutting and spraying.

M21GWBK	Black	40", 60", 72" width; 50 yds/roll
		Service range: -30/1200°F

FIBREGLASS - NO COATING – 18 oz. untreated fiberglass cloth. Our best value for light duty welding protection from spark and spatter. Has limited abrasion and tensile strength characteristics, intended uses are limited to welding covers.

M18GT	Tan	40", 60", 72" width; 50 yds/roll
		Service range: -30/1200°F

PREMIUM TRANSPARENT GRADE ROLL GOODS

SAF-T-VU™* – Transparent .012" to .014" vinyl film is CFM approved. Ideal for curtains and screens where visibility is required and protection is provided against UV light and light forms of flying debris.

M1063	Yellow	64" width; 100 yds/roll
M1063OSV	Orange	74.5" width; 86 yds/roll
M1063BSB	Blue	Service range: 3/165°F
M1063GSV	Green	
M1063GYSV	Gray	
M1063SH8	Shade 8	
M1063C	Clear	74.5" width; 101 yds/roll

SAF-T-VU2™* – Extra heavy duty PVC material helps control noise level. Use for machinery area partitions where visibility with optical protection is required, and vertical curtains.

M1103	Clear	54" width; 30 yds/roll; 40ml
M1102	Orange	48" width; 30 yds/roll; 80ml
M1096	Clear	48" width; 20 yds/roll; 80ml
M1094	Amber	48" width; 15 yds/roll; 80ml
M1108	Shade 8	48" width; 15 yds/roll; 80ml
M1105	Clear	48" width; 30 yds/roll; 120ml
M1097	Clear	48" width; 20 yds/roll; 160ml
		Service range: 3/165°F

NOTE: *SAF-T-VU and SAF-T-VU 2 are not intended for use in lieu of visors, goggles or view port windows for welding operations; clear material has no ultraviolet filtering capabilities and is recommended for physical protection only.

ANTI-STATIC SAF-T-VU* – Clear .012" to .014" vinyl with a conductive scrim that grounds static charges. For isolating areas that must be kept clean and free of static charges. Meets military specifications B-81705B for surface resistivity.

M1083	Clear	54" width; 100 yds/roll
		Service range: 3/165°F

NOTE: Service ranges listed above are intended as guidelines, based on recommended usage. Frommelt Safety Products is not responsible for misapplication of fabrics or any consequences thereof.

Welding / Safety Blankets



Premium Grade Blankets

Fire-resistant blankets are used to protect equipment and personnel near potentially hazardous or messy operations, such as welding, grinding or spraying. Available in a variety of fabric options to service light to heavy duty applications.

Weight	Base Fabric	Color	Max. Temp.	6' x 6'	9' x 12'
28 oz.	Fro-Guard	Gold	1000°F	B66FG	B912FG
23 oz.	Thermo-shield™*	Blue/Black	1200°F	B66TBL	B192TBL
19 oz.	Silica	Tan	3000°F	B66SL	B912SL

NOTES: Cut sizes are listed; special sizes are available in all fabrics. Blue will be shipped unless black is specified. Grommets are placed every 36" on all four sides.



Commercial Grade Covers are attractively packaged for store display.

Commercial Grade Blankets

Weight	Base Fabric	Treatment	Color	Max. Temp.	Size - Part No.		
					6' x 6'	6' x 8'	6' x 10'
24 oz.	Neoshield	Neoprene	Gold	1000°F	6624GNY	6824GNY	61024GNY
24 oz.	Neoshield	Neoprene	Blue	1000°F	6624GNB	6824GB	61024GB
21 oz.	Fiberglass	Shedcote	Black	1200°F	6621GWBK	6821GWBK	61021GWBK
18 oz.	Fiberglass	untreated	Tan	1000°F	6618GT	6818GT	61018GT
18 oz.	Silica	untreated	Tan	3000°F	6618ST	6818ST	61018ST
34 oz.	Silica	untreated	Tan	3000°F	6634ST	6834ST	61034ST

NOTE: Custom sizes available for blankets, consult factory.

First Sight Neoshield™

Highly visible colored covers signal hazards associated with welding, grinding or spraying in production areas. Workers may be unaware of manufacturing hazards, particularly in overhead areas until it's too late. Covers are made with a popular 24-ounce fiberglass material with a neoprene coating on one side to protect against sparks and molten metal. Withstands temperature exposure of up to 1000°F. Covers are grommeted on four corners and in the middle of the long sides. Available in Safety Orange, Safety Yellow, and Safety Green.

Color	Size - Part No.		
	6' x 6'	6' x 8'	6' x 10'
Fluorescent Orange	6624GNIO	6824GNIO	61024GNIO
Fluorescent Yellow	6624GNII	6824GNII	61024GNII
Fluorescent Green	6624GNIG	6824GNIG	61024GNIG

CUSTOM SIZES AVAILABLE FOR COVERS, CONSULT FACTORY FOR DETAILS.
 NOTE: *Actual Size may vary by 3" in height and width. Brass tie-down grommets located at corners and center of long sides. 10' x 12' size includes grommets on all four sides as well as in corners.

Cool Hand™ Protectors

Protect your hands from high radiant arc heat during welding operations and increase the service life of gloves with this protective covering. Reflective surface and protective backing permit longer welds at high amperages.



FEATURES

- Made of special aluminized fiber blend non-asbestos fabric.
- Elastic bands hold Cool Hand snugly in place, yet allows free finger movement.



Part No. COLH-2

Attractive
Point-of-Purchase
Hang Card

Protective Sleeves



Arm protection in a lightweight, comfortable sleeve. Job-matched to resist heat, splash, oils, caustics, sparks, etc.

Length	14 oz. Duck	
	Green	Yellow
14"	930G	930Y
18"	931G	931Y

Protect workers from the hazards associated with welding, grinding, cutting and other operations. Aluminum frames are durable, light weight, and resistant to corrosion. Opaque Weld-Tex or canvas duck and tinted transparent Saf-T-Vu material panel options are available in a vented design (SV) which offers 12" airflow from bottom of screen to floor, or top-to-bottom full coverage (SF) models. Single and multiple frame designs up to 32' in width are available in 5' and 6' heights. Each frame has it's own fabric panel which facilitates economical replacement. Overlapping fabric panels eliminate gaps between frames. Single panel units include crossbar legs.

FEATURES

- Pocket style fabric panels facilitate quick assembly
- Light weight and durable aluminum frame
- Single and multiple panel, vented and non-vented options
- Caster option available for all models
- Custom sizes available

ACCESSORIES

Customize your OSS Screens with casters, crossbar legs and hinges.



Vented (SV)



Full Coverage (SF)



Metal connectors are durable and set-up is simplified.

FABRIC CODES (Example: SV56DG1 is a 5'H x 6'W, green duck, 1 panel screen.)

DG = Green Duck	WG = Green Weldtex	SG = Green PVC	SY = Yellow PVC
DY = Yellow Duck	WY = Yellow Weldtex	SGY = Gray PVC	SB = Blue PVC
DB = Blue Duck	WB = Blue Weldtex	SC = Clear PVC	SO = Orange PVC
SH8 = Shade 8			

Vented Style OSS Curtains						Full Style OSS Curtains					
Size(hxw)	Panels	Duck	Weldtex	Zebra	Saf-T-Vu	Size(hxw)	Panels	Duck	Weldtex	Zebra	Saf-T-Vu
5x6	1- 5X6	SV56DX1	SV56WX1	SV56Z1	SV56SX1	5x6	1- 5X6	SF56DX1	SF56WX1	SF56Z1	SF56SX1
5x12	2- 5X6	SV56DX2	SV56WX2	SV56Z2	SV56SX2	5x12	2- 5X6	SF56DX2	SF56WX2	SF56Z2	SF56SX2
5x18	3- 5X6	SV56DX3	SV56WX3	SV56Z3	SV56SX3	5x18	3- 5X6	SF56DX3	SF56WX3	SF56Z3	SF56SX3
5x24	4- 5X6	SV56DX4	SV56WX4	SV56Z4	SV56SX4	5x24	4- 5X6	SF56DX4	SF56WX4	SF56Z4	SF56SX4
6x4	1- 6X4	SV64DX1	SV64WX1	SV64Z1	SV64SX1	6x4	1- 6X4	SF64DX1	SF64WX1	SF64Z1	SF64SX1
6x8	2- 6X4	SV64DX2	SV64WX2	SV64Z2	SV64SX2	6x8	2- 6X4	SF64DX2	SF64WX2	SF64Z2	SF64SX2
6x12	3- 6X4	SV64DX3	SV64WX3	SV64Z3	SV64SX3	6x12	3- 6X4	SF64DX3	SF64WX3	SF64Z3	SF64SX3
6x16	4- 6X4	SV64DX4	SV64WX4	SV64Z4	SV64SX4	6x16	4- 6X4	SF64DX4	SF64WX4	SF64Z4	SF64SX4
6x6	1- 6X6	SV66DX1	SV66WX1	SV66Z1	SV66SX1	6x6	1- 6X6	SF66DX1	SF66WX1	SF66Z1	SF66SX1
6x12	2- 6X6	SV66DX2	SV66WX2	SV66Z2	SV66SX2	6x12	2- 6X6	SF66DX2	SF66WX2	SF66Z2	SF66SX2
6x18	3- 6X6	SV66DX3	SV66WX3	SV66Z3	SV66SX3	6x18	3- 6X6	SF66DX3	SF66WX3	SF66Z3	SF66SX3
6x24	4- 6X6	SV66DX4	SV66WX4	SV66Z4	SV66SX4	6x24	4- 6X6	SF66DX4	SF66WX4	SF66Z4	SF66SX4
6x8	1- 6X8	SV68DX1	SV68WX1	SV68Z1	SV68SX1	6x8	1- 6X8	SF68DX1	SF68WX1	SF68Z1	SF68SX1
6x16	2- 6X8	SV68DX2	SV68WX2	SV68Z2	SV68SX2	6x16	2- 6X8	SF68DX2	SF68WX2	SF68Z2	SF68SX2
6x24	3- 6X8	SV68DX3	SV68WX3	SV68Z3	SV68SX3	6x24	3- 6X8	SF68DX3	SF68WX3	SF68Z3	SF68SX3
6x32	4- 6X8	SV68DX4	SV68WX4	SV68Z4	SV68SX4	6x32	4- 6X8	SF68DX4	SF68WX4	SF68Z4	SF68SX4

NOTES: SAF-T-VU fabric is not intended for use in lieu of visors, goggles or view port windows for welding operations.



Our Econo Welding Screens feature a light weight frame that is easy to assemble. The curtains are hemmed and grommets on all four sides. These screens are single panels which include metal connecting tees and crossbar legs. Choose from Saf-T-Vu Yellow, Orange or Green and Duck fabric in Green, Yellow or Blue.

Size in Feet			6'H x 6'W			6'H x8'W		
Fabric	Color	Part No.	Fabric	Color	Part No.	Fabric	Color	Part
Saf-T-Vu	Yellow	ES56SY	Saf-T-Vu	Yellow	ES66SY	Saf-T-Vu	Yellow	ES68SY
Saf-T-Vu	Orange	ES56SO	Saf-T-Vu	Orange	ES66SO	Saf-T-Vu	Orange	ES68SO
Saf-T-Vu	Green	ES56SG	Saf-T-Vu	Green	ES66SG	Saf-T-Vu	Green	ES68SG
Duck	Green	ES56DG	Duck	Green	ES66DG	Duck	Green	ES68DG
Duck	Yellow	ES56DY	Duck	Yellow	ES66DY	Duck	Yellow	ES68DY
Duck	Blue	ES56DB	Duck	Blue	ES66DB	Duck	Blue	ES68DB

SAF-T-VU** – Transparent .012" to .014" vinyl film is CFM approved. Use for partitions where visibility with optical protection is required.

NOTE: Multiple panel and additional sizes and fabrics are available in OSS models.



Overall Size (HxW in feet)	Zebra
4x6	290-Z
4x9	465-Z
5x6	298-Z

NOTE: For other fabrics and sizes, consult factory.

These shields provide low-cost protection for most hazardous operations, and they roll up for easy portability. Applications include protection for welding areas, cutting or brazing; isolating workers or equipment; and spray protection.

Features

- Sturdy 14-gauge wire mesh construction.
- Complete screening to the floor.
- Two-sided cover, built-in handle and tie strap.

Screen Accessories

Casters
2" diameter swivel casters let you move screens quickly and easily. Order one more than the number of panels on your screen. (Stock No. C-60)



Hinges
Joins tubular-framed screen panels into flexible easy-to-move, easy-to-store multiple-panel screens. Set of 2. (Stock No. HS-2)

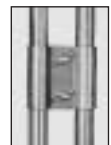

Crossbar Legs
Sold in sets of two legs. Available with or without casters. Adds stability to multiple-panel screens. Order one more than the number of panels in your screen. (Stock No. CBL-93 w/o casters and Stock No. CBL-93C with casters)



OSS Screens

These economical multi-purpose curtains come hemmed and ready to hang on tubing or framing you supply. Choice of two heights, and widths from 6' to 15'. Applications include protection for welding areas, cutting or brazing; isolating workers or equipment; and spray protection.



Features

- Hemmed for extra strength and longer service life.
- Grommets every 12" across top and at each corner of bottom.
- Available in 11 material/color choices.
- Attaches quickly and easily on pipes up to 2" O.D. with accessory hooks.

Size* (h x w)	Fabrics									
	Duck** Green	Weldtex** Green	Zebra	Saf-T-Vu Yellow	Saf-T-Vu Blue	Saf-T-Vu Green	Saf-T-Vu Orange	Saf-T-Vu Gray	Saf-T-Vu Clear	Saf-T-Vu Shade 8
5x6	C56DG	C56WG	C56Z	C56SY	C56SB	C56SG	C56SO	C56SGY	C56SC	C56SH8
5x8	C58DG	C58WG	C58Z	C58SY	C58SB	C58SG	C58SO	C58SGY	C58SC	C58SH8
5x9	C59DG	C59WG	C59Z	C59SY	C59SB	C59SG	C59SO	C59SGY	C59SC	C59SH8
5x10	C510DG	C510WG	C510Z	C510SY	C510SB	C510SG	C510SO	C510SGY	C510SC	C510SH8
5x12	C512DG	C512WG	C512Z	C512SY	C512SB	C512SG	C512SO	C512SGY	C512SC	C512SH8
5x15	C515DG	C515WG	C515Z	C515SY	C515SB	C515SG	C515SO	C515SGY	C515SC	C515SH8
6x6	C66DG	C66WG	C66Z	C66SY	C66SB	C66SG	C66SO	C66SGY	C66SC	C66SH8
6x8	C68DG	C68WG	C68Z	C68SY	C68SB	C68SG	C68SO	C68SGY	C68SC	C68SH8
6x9	C69DG	C69WG	C69Z	C69SY	C69SB	C69SG	C69SO	C69SGY	C69SC	C69SH8
6x10	C610DG	C610WG	C610Z	C610SY	C610SB	C610SG	C610SO	C610SGY	C610SC	C610SH8
6x12	C612DG	C612WG	C612Z	C612SY	C612SB	C612SG	C612SO	C612SGY	C612SC	C612SH8
6x15	C615DG	C615WG	C615Z	C615SY	C615SB	C615SG	C615SO	C615SGY	C615SC	C615SH8

IMPORTANT: Standard grommeting is bottom corners and on 12" centers across the top.

NOTES: *Finished sizes are listed; special sizes are available

**Green will be shipped unless yellow or blue is specified

SAF-T-VU fabric is not intended for use in lieu of visors, goggles or view port windows for welding operations.

Custom Welding/Safety Curtains



Custom curtains can be made in virtually any size using any one of our wide variety of fire-retardant fabrics. We can design and build a curtain to meet your exact needs while staying within your budget.

Custom protect any area with:

- Cut-outs for conveyor or machinery clearance.
- Viewport windows for enhanced visibility.
- Hook and loop fastening for pedestrian or equipment entrance.
- Chain weighted bottom hems for stability against air movement.

When designing a custom curtain, there are several factors that need to be taken into consideration in order to select the right curtain for your needs. Important factors include fabric characteristics, functionality, hazard assessment, space, ergonomic issues and cost involved in protecting personnel in the area.

Safety Curtain Accessories



Touch-and-Hold Fasteners

For easy access between sections of material. 1" wide strips are sewn in place for secure fastening and easy pull-apart opening. (Stock No. THF-1)

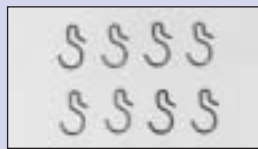

Curtain Hooks

Shaped for hanging grommeted fabric from 1" or 2" pipe. (Stock No. OCH1 for 1" pipe and Stock No. OCH2 for 2" pipe)



Hem Weight Chain

Flexible link chain, weighing 5 oz. per linear foot, helps stabilize hanging curtains against air movement. Factory-sewn into bottom hem. (Stock No. RC030)

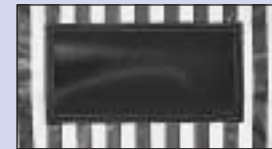

View Port Window

Flexible window - 10" by 20" - attaches easily and securely with touch-and-hold fasteners. SAF-T-VU material allows safe observation of welding operations. Window comes standard made of Shade 8. (Stock No. VPW-60) Other shades available

Custom Saf-T-Strip Curtains / Strip Doors

Flexible transparent PVC strip provides protection from harmful ultra-violet rays associated with welding operations. Strips are always in position for optimal protection, can easily be replaced, provide unlimited access and also function as a barrier to unwanted noise. Strips are punched with holes on 2" centers to fit over studs on MB14 mounting brackets. Partial overlap provides a gapless seal and is suitable for most applications. Use full overlap for maximum thermal protection or noise reduction.



Features

- Available in UV-filtering amber, orange and blue for welding protection, plus clear.
- Hinge arm mount.
- Effective sound attenuation capabilities.

Fabric Description								
Strip Width	Strip Thickness	Strip Fabric	Partial Overlap Part No.	Full Overlap Part No.	Replacement Part No.	Feet/ Roll	Lbs./ Roll	
6"	0.040	UV Amber	SY634	-	RSY6	500	70	
8"	0.080	UV Amber	SY850	SY800	RSY8	300	100	
8"	0.080	UV Orange	SO850	SO800	RSO8	300	100	
8"	0.080	UV Blue	SB850	SB800	RSB8	300	100	
12"	0.120	UV Amber	SY1234	SY1200	RSY12	200	155	
16"	0.160	UV Amber	SY1634	SY1600	RSY16	150	200	

NOTE: *Saf-T-Strip material is not intended to take the place of visors, goggles and/or helmets for eye protection.

Replacement strips are available in full rolls, partial rolls or individual strips. Individual strips are pre-punched on 2" centers and cut to your specified length. Full and partial rolls are not pre-punched.

Strip Doors



Strip Door Kits For Standard Door Openings

Combine MB14 mounting brackets with your choice of clear vinyl strip to meet your specific door application and size. Control energy loss and cross-contamination with effective, economical and easy to install strip doors. Standard materials appropriate for use in temperatures range of 0°F to 150°F. Low temperature and ribbed strip materials available upon request.

How to order:

Partial overlap design is suitable for most applications. Use full overlap for extreme applications where maximum energy control or sound attenuation is desired or excessive air movement is present. For most applications, use 8" thick strips for 8' high openings, 12" for 12', and 16" wide strips for 16' high openings. Identify surface or header mount application, length of MB14 mounting bracket needed and dimensions of opening. Apply part numbers shown below to the corresponding price per square foot. Orange colored safety strips to be positioned at door ends are an option available at no additional charge.

Choice of two overlap configurations.



Fabric Description								
Clear Width	Vinyl Strip Thickness	Overlap	Part No.	Overlap	Part No.	Replacement Part No.	Feet/ Roll	Lbs./ Roll
6"	.040"	67%	SC634	-	-	RSC6	400	75
8"	.080"	50%	SC850	100%	SC800	RSC8	300	100
12"	.120"	67%	SC1234	100%	SC1200	RSC12	200	155
16"	.160"	50%	SC1634	100%	SC1600	RSC16	150	200

MB14 Universal Mounting Bracket

14 gauge, hot dipped, galvanized steel. Includes cover plates and wing nuts. Punched strips fit over studs welded to bracket and then are secured in place with cover plates and wing nuts. Versatile design allows bracket to be surface mounted above door opening or header mounted.

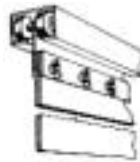
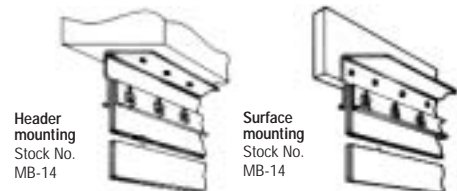

T-880 Track
SSR Trolley

SSR Strip Door Trolley

Roll strip doors out of the way by mounting strip to the SSR strip door trolley. See page 11 for applications with roller track.

Mounting Hardware

FST Floor Support

Attach MB14 mounting brackets to FST floor supported uprights. 1.25" square galvanized tubular steel with a 1/4" thick base.

Part Number	Height
FST6	6'
FST7	7'
FST8	8'



Standard Welding/Safety Curtains

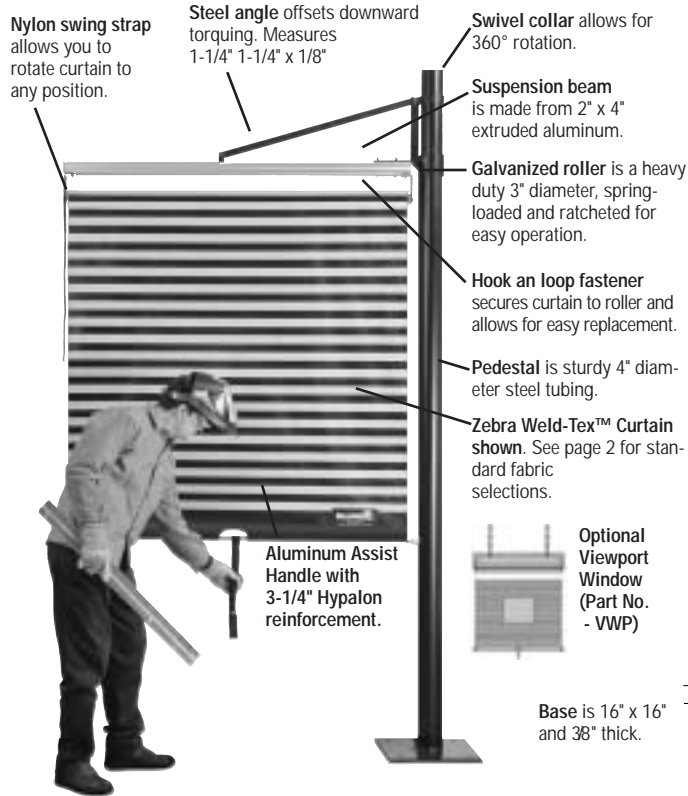

The unique up-down-swivel motion of the Roll Shield retractable curtain provides protection in areas where other conventional curtains and screens fall short. Readily adaptable to changing manufacturing layouts and processes, the Roll Shield protects workers from harmful ultraviolet light, heat, sparks and flying debris while maintaining unobstructed overhead access for maximum safety and productivity.

A heavy duty ratchet action roller allows the curtain to be locked into any vertical position with a light tug on the nylon pull strap. With another light tug, the spring-tensioned curtain roller allows the curtain to be rolled up and stored safely out of the way. Curtain attaches to the roller with hook and loop fastener for ease of replacement.

A 2" x 4" extruded aluminum beam provides plenty of strength for the Roll Shield to be suspended overhead, mounted in a cantilevered position off a wall or mounted on a pedestal base. Two Roll Shields can be mounted to one pedestal for corner protection. Swivel models allow for a 360° range of motion. Collar stops to limit range are available options.

Roll Shields are available in heights of up to 10' and lengths of up to 15'. Curtains are available in transparent Saf-T-VU™ and opaque Weld-Tex™ materials. Consult factory for custom sizes and other specialized material applications.

Base is 16" x 16" and 38" thick.

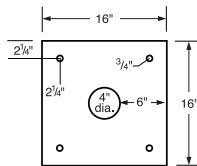

Size (WxH)	Saf-T-Vu			Weldtex			Zebra		
	Standard	Swivel	Curtain Only	Standard	Swivel	Curtain Only	Standard	Swivel	Curtain Only
6x8	RS6-SV	RSS6-SV	2841-SV6	RS6-WT	RSS6-WT	2841-WT6	RS6-Z	RSS6-Z	2841-Z6
7x8	RS7-SV	RSS7-SV	2841-SV7	RS7-WT	RSS7-WT	2841-WT7	RS7-Z	RSS7-Z	2841-Z7
8x8	RS8-SV	RSS8-SV	2841-SV8	RS8-WT	RSS8-WT	2841-WT8	RS8-Z	RSS8-Z	2841-Z8
9x8	RS9-SV	RSS9-SV	2841-SV9	RS9-WT	RSS9-WT	2841-WT9	RS9-Z	RSS9-Z	2841-Z9
10x8	RS10-SV	RSS10-SV	2841-SV10	RS10-WT	RSS10-WT	2841-WT10	RS10-Z	RSS10-Z	2841-Z10
11x8	RS11-SV	RSS11-SV	2841-SV11	RS11-WT	RSS11-WT	2841-WT11	RS11-Z	RSS11-Z	2841-Z11
12x8	RS12-SV	RSS12-SV	2841-SV12	RS12-WT	RSS12-WT	2841-WT12	RS12-Z	RSS12-Z	2841-Z12
13x8	RS13-SV	RSS13-SV	2841-SV13	RS13-WT	RSS13-WT	2841-WT13	RS13-Z	RSS13-Z	2841-Z13
14x8	RS14-SV	RSS14-SV	2841-SV14	RS14-WT	RSS14-WT	2841-WT14	RS14-Z	RSS14-Z	2841-Z14
15x8	RS15-SV	RSS15-SV	2841-SV15	RS15-WT	RSS15-WT	2841-WT15	RS15-Z	RSS15-Z	2841-Z15

NOTE: Custom sizes available. Consult factory.

For Swivel Roll-Shield Only:

When ordering a Swivel Roll-Shield choose from the two mounting styles shown:

Floor-Mounted Pedestal (FPD)

Part No.	Height
FPD-8	8'
FPD-9	9'
FPD-10	10'
FPD-11	11'
FPD-12	12'

Can be supplied by others

4" O.D. Tube (Black)

Wall-Mounted Pedestal (WPD)

4" O.D. Tube (Black)

Part No. - WPD (2 wall brackets and 4" O.D. tube.)

NOTE: Mounting pedestals and brackets are optional and must be ordered separately from the Swivel Roll-Shield.

Standard Welding/Safety Curtains

Features

- Manual Roll-up Safety Curtain extends and retracts sideways up to 20'.
- Spring tensioned aluminum roller keeps curtain taut and automatically retracts curtain to stored position.
- Curtain stores safely and out of harms way requiring minimal floor space.
- Does not require overhead suspension eliminating obstructions to overhead equipment and process.
- Ideal for larger openings where frequency of use is low but full access is a requirement.
- Curtains attach to roller with hook and loop fasteners for ease of replacement.
- Standard curtain heights are 3' and 4' and widths up to 20'.

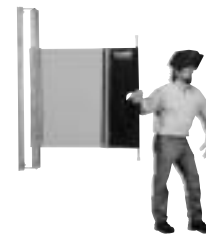

Specify color by adding suffix to part number:
SAF-T-VU: Y = yellow, G = green, O = orange,
BSB = Blue, C = clear, GY = gray, SH8 = Shade 8
Weld-Tex: Y = yellow, G = green

Size (WxH in feet)	SAF-T-VU	Fabrics Weld-Tex	Zebra
12x3	STS312-SV	STS312-WT	STS312-Z
20x3	STS320-SV	STS320-WT	STS320-Z
12x4	STS412-SV	STS412-WT	STS412-Z
20x4	STS420-SV	STS420-WT	STS420-Z

Custom Welding/Safety Curtains



Size (WxH in feet)	SAF-T-VU	Fabrics	
		Weld-TEX	Zebra
13x5	XT513-SV	XT513-WT	ST513-Z
26x5	XT526-SV	XT526-WT	ST526-Z
13x6	XT613-SV	XT613-WT	ST613-Z
26x6	XT626-SV	XT626-WT	ST626-Z

NOTE: Custom sizes available. Consult factory.

Features

- Combines a safety curtain and a suspension device into a versatile area protection system.
- Conveniently extends and retracts, spanning distances of up to 26 feet.
- Used in combination with additional curtains for corner, perimeter, or open floor cells.
- Ideal for manufacturing workcells where overhead suspension systems can interfere with material handling. Cable and curtain can be removed easily, enabling passage of overhead cranes and material handling equipment then re-extend for safe area protection.

Saf-T-Glide™

The Saf-T-Glide cantilever curtain provides protection over long expanses without the inconvenience of an end post. Curtains easily slide on plastic clips over the length of the beam. Mounting options allow the beam to swivel out of the way which makes the Saf-T-Glide ideal where bridge cranes are used. Standard sizes are shown to the right. Custom sizes with multiple curtain material options are available. Assembly includes curtain, hooks and plastic gliders, 2" x 4" extruded aluminum beam, and swivel bracket.



Size (WxH in feet)	SAF-T-VU	Weld-TEX	Zebra
12x10	CSC1210-SV	CSC1210-WT	CSC1210-Z
14x12	CSC1412-SV	CSC1412-WT	CSC1412-Z
18x12	CSC1812-SV	CSC1812-WT	CSC1812-Z
18x14	CSC1814-SV	CSC1814-WT	CSC1814-Z

NOTE: Custom sizes available. Consult factory.

Roller Curtains

Divide open spaces quickly and easily with these versatile roll-into-place curtains, custom-manufactured for your specific needs. They move quietly and smoothly in a permanent track to form enclosures, corner partitions, wall-to-wall partitions, or cubicles. Available in any size, shape or height, with or without hardware. Applications include protection for welding, cutting, grinding, brazing or spraying; isolating workers or equipment; and creating temporary offices or booths.

Features

- Choice of suspension methods: wall, ceiling, beam, suspension or floor mount.
- Heavy 16-gauge steel track and hardware.
- Quiet, smooth-running rollers.
- Available in 28 material/color choices.



Fabrics

Frommelt Safety Products will fabricate roller curtains for you in the fabric which fits your needs best. See Roll Goods chart for fabric descriptions and ordering numbers.

Accessories

Customize your roller curtains with curtain hooks, touch-and-hold fasteners, hem weight chain and view port window.



How to Order Roller Curtain Installation Components

Use this diagram, together with the steps shown on page 11, to help identify track and support components required for your custom installation

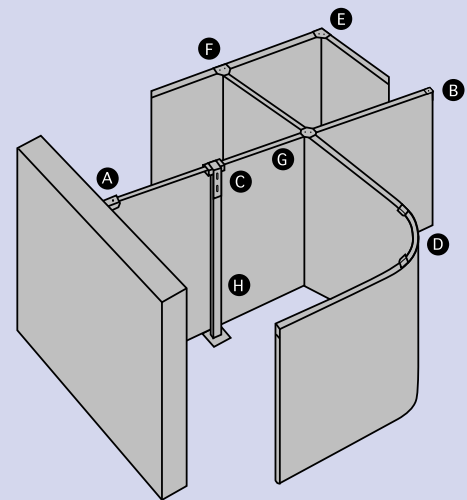

Saf-T- Cell / Roller Curtain Hardware

Heavy Duty Framework

Saf-T-Cell™ is a very flexible, floor mounted system of components which provides the framework for manufacturing cell construction. Attach Saf-T-Vu™ curtains, Saf-T-Strip™, sound attenuation panels, or choose from any of Frommelt's wide range of fabrics for your specific area protection application.

Vertical supports (VC) are fabricated from 3"x3" tubular steel and have 12" base plates. Horizontal rails (HR) are 12 gauge and are available in lengths up to 12'. A simple to use system of couplers facilitates a wide range of possible configurations. All components are painted safety yellow.

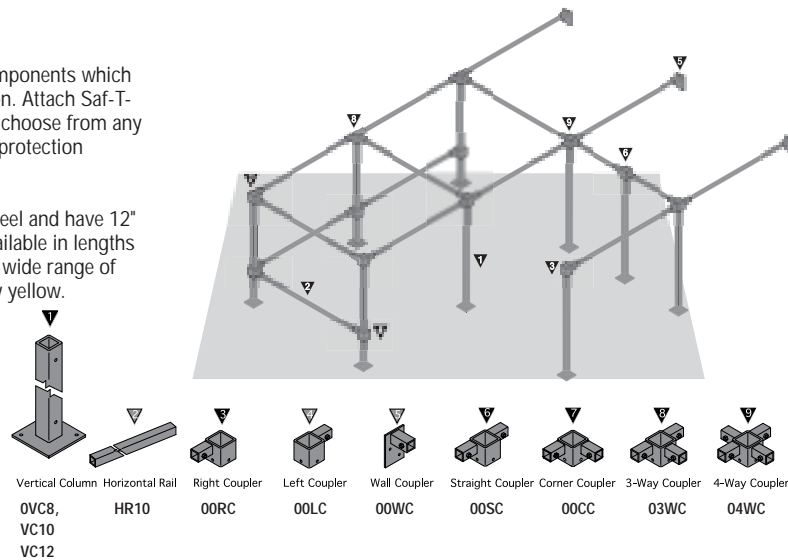

Panels



Noise control products reduce harmful and annoying noise and vibration levels to protect workers and increase productivity. They can become part of any in-plant or field safety program or the design of a variety of OEM products.

Our premium sound attenuation products. Incorporating the premium barrier characteristics of our 1 lb/ft² loaded reinforced vinyl (M-2002) and the absorption characteristics of our quilted fibrous glass, offering both the M-2004 and our M-2006.

The M-2004 includes a 2" baffle sewn to one side of the panel while the M-2006 includes 1" baffles sewn on both sides of each panel. Each panel is sewn custom per your application—no standard sizes. Please consult factory for a quotation for your project.

Baffles



Baffle Thickness

Part No.	1"	2"
	BP1-24	BP2-24

Note: Consult factory for USDA applications and other specialty baffles.

Primarily used to reduce reflective noise within a facility, these fibrous glass baffles are enclosed in quilted aluminized fabric for protection against oil, grease, dirt and moisture. Grommets in three corners allow baffles to be suspended easily to any application. They are available in standard 2' x 4' and custom sizes. All pricing requested on project to project quotation basis only.

Sound Enclosures

Custom Sound Enclosures Designed with PVC Strips and Sound Attenuation Panels

Frommelt Safety's family of noise control products includes PVC Strips and Sound Attenuation Panels that are designed for individual use or in a myriad of combinations to effectively reduce harmful and annoying noise, protect workers and increase productivity. Can be specified as part of any in-plant safety program. Panels incorporate 1 lb./ft² loaded reinforced vinyl; sewn per application.



After installation was complete (shown above), test results showed a better than 10 percent reduction in dBA outside the CNC turrets, contributing significantly to worker comfort levels and eliminating the need for dual hearing protection in adjacent production areas.

PVC Curtains

Our standard SAF-T-VU-2 curtains and our strip doors/curtains also have excellent sound attenuation characteristics.

Random Incidence Absorption Coefficients

Part No.	Sound frequency in Hz					
	125	250	500	1000	2000	4000 NRC
BP1-24	.17	.30	.84	.82	.58	.37 .65
BP2-24	.38	.89	.82	.78	.51	.35 .75

Data based on tests by Riverbank Acoustical Laboratories; details available from Frommelt Safety Products.

Sound Attenuation Characteristics

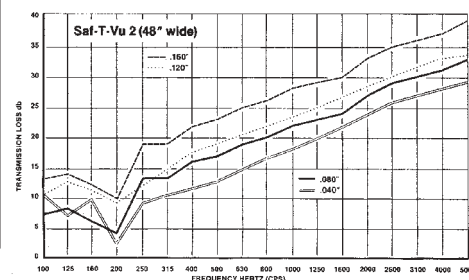
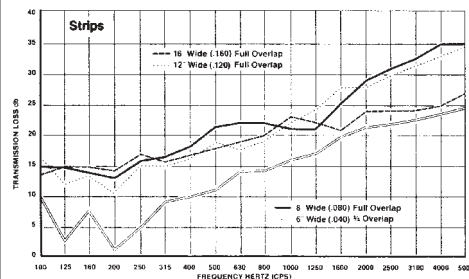

Roller Curtains

STEP 1

Is track coming off a wall?

A YES:

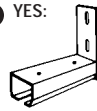

EW-006
Wall End Support (up)



EW-007
Wall End Support (down)
(Plate: 1-1/2" x 2-1/4")

B NO:



ES-010
End Stop

STEP 2

Length of track (in feet) needed?

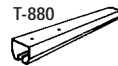

T-880
Straight Track
NOTE: For track to ship UPS, pieces must be no greater than 8' in length.
Freight shipments can accept 12' sections.

STEP 3

Is length of track greater than 7', or are multiple pieces of track being used?

NO: Proceed to step 4

C YES:

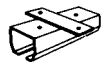

CS-008
Ceiling Mount Straight
Connector/Support



BS-009
Beam Mount Straight
Connector/Support
(Plate: 2" x 2")



FS-011
Floor Mount Straight
Connector/Support

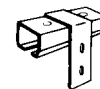

WM-004
Wall Mount Straight
Connector/Support
(Plate: 1-1/2" x 3-1/4")



SC-005
Straight Connector

STEP 4

Does enclosure consist of more than 1 side?

NO: Proceed to step 5

YES:

D If enclosure is 2-sided and curtain needs to pass around corner:
NOTE: Deduct 4' of T-880 straight track for each 90° curve used.



CC-012
Ceiling Mount/90° Curved
Track (3 Supports)



CB-014
Beam Mount/90° Curved
Track (3 Supports)



CF-015
Floor Mount/90° Curved
Track (3 Supports)

E If enclosure is 2-sided and curtain does not need to pass around corner,
or for 2-way intersection:

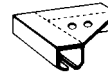

CAC-034
Ceiling Mount/90° Corner
Connector (5-3/4" x 5-3/4")



BAC-031
Beam Mount/90° Corner
Connector

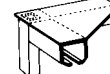

FAC-037
Floor Mount/90° Corner
Connector

F If enclosure requires a 3-way intersection:

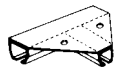

CTC-035
Ceiling Mount/3-Way
"T" Connector (12" x 12")

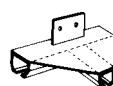

BTC-032
Beam Mount/3-Way "T"
Connector

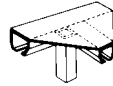

FTC-038
Floor Mount/3-Way "T"
Connector

G If enclosure requires a 4-way intersection:

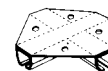

C4C-036
Ceiling Mount/4-Way
Connector (12" x 12")

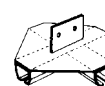

B4C-033
Beam Mount/4-Way
Connector

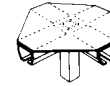

F4C-039
Floor Mount/4-Way
Connector

STEP 5

Is enclosure floor supported?

H NO: Proceed to step 6

YES:

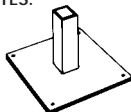

FMB-040
Floor Mount Support Base
(Plate: 12" x 12")



FMC-046
Floor Mount Support Column
(6 ft. Track Height)

FMC-047
(7 ft. Track Height)

FMC-048
(8 ft. Track Height)

NOTE: Support column and base required every 7' and at each corner.

STEP 6

Is overlap required on enclosures with multiple curtains?

NO: Proceed to step 7

YES:



BPR
By-Pass Roller* (Permits Overlap of 2 Curtains)
(12" long x 2-3/4" high)

NOTE: One BPR allows two adjoining curtains to overlap

STEP 7



NR-015
Two-Wheel Roller, Nylon Wheel
(2" long)

NR-017
Two-Wheel Roller, Nylon Wheel
(2-1/2" long)



SR-016
Two-Wheel Roller, Steel Wheel*
(2" long)

SR-018
Two-Wheel Roller, Steel Wheel*
(2-1/2" long)

NOTE: Steel wheel rollers required on Armor Pleat or PVC curtains of .80 mil weight or more. *Includes steel ball bearings.